

TPS723xx 200mA Low-Noise, High-PSRR Negative Output Low-Dropout Linear Regulators

1 Features

- Ultralow Noise: 60 μV_{RMS} Typical
- High PSRR: 65 dB Typical at 1 kHz
- Low Dropout Voltage: 280 mV Typical at 200 mA, 2.5 V
- Available in -2.5-V and Adjustable (-1.2 V to -10 V) Versions
- Stable With a $2.2\text{-}\mu\text{F}$ Ceramic Output Capacitor
- Less Than $2\text{-}\mu\text{A}$ Typical Quiescent Current in Shutdown Mode
- 2% Overall Accuracy (Line, Load, Temperature)
- Thermal and Over-Current Protection
- SOT23-5 (DBV) Package
- SOT-5 (DDC) Package
- Operating Junction Temperature Range: -40°C to 125°C

2 Applications

- Optical Drives
- Optical Networking
- Noise Sensitive Circuitry
- GaAs FET Gate Bias
- Video Amplifiers

3 Description

The TPS723xx family of low-dropout (LDO) negative voltage regulators offers an ideal combination of features to support low noise applications. These devices are capable of operating with input voltages from -10 V to -2.7 V , and support outputs from -10 V to -1.2 V . These regulators are stable with small, low-cost ceramic capacitors, and include enable (EN) and noise reduction (NR) functions. Thermal short-circuit and over-current protections are provided by internal detection and shutdown logic. High PSRR (65 dB at 1 kHz) and low noise ($60\text{ }\mu\text{V}_{\text{RMS}}$) make the TPS723xx ideal for low-noise applications.

The TPS723xx uses a precision voltage reference to achieve 2% overall accuracy over load, line, and temperature variations. Available in a small SOT23-5 package, the TPS723xx family is fully specified over a temperature range of -40°C to 125°C .

Device Information⁽¹⁾

PART NUMBER	PACKAGE ⁽²⁾	BODY SIZE (NOM)
TPS723xx	SOT-23 (5)	2.90 mm x 1.60 mm
	SOT (5)	2.90 mm x 1.60 mm

(1) For all available packages, see the orderable addendum at the end of the datasheet.

(2) The two SOT23 packages are identical in size, but the SOT package is thinner.

Typical Application Circuit

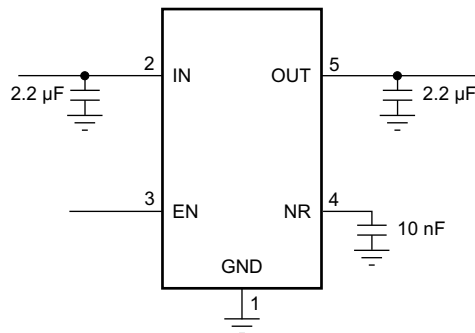

Table of Contents

1 Features	1	8 Application and Implementation	13
2 Applications	1	8.1 Application Information.....	13
3 Description	1	8.2 Typical Application	13
4 Revision History	2	8.3 Do's and Don'ts.....	14
5 Pin Configuration and Functions	3	9 Power-Supply Recommendations	15
6 Specifications	4	10 Layout	15
6.1 Absolute Maximum Ratings	4	10.1 Layout Guidelines	15
6.2 Handling Ratings.....	4	10.2 Layout Example	15
6.3 Recommended Operating Conditions.....	4	10.3 Power Dissipation	15
6.4 Thermal Information	4	10.4 Thermal Protection.....	15
6.5 Electrical Characteristics.....	5	11 Device and Documentation Support	16
6.6 Typical Characteristics	6	11.1 Device Support.....	16
7 Detailed Description	11	11.2 Related Links	16
7.1 Overview	11	11.3 Trademarks	16
7.2 Functional Block Diagrams	11	11.4 Electrostatic Discharge Caution.....	16
7.3 Feature Description.....	12	11.5 Glossary	16
7.4 Device Functional Modes.....	12	12 Mechanical, Packaging, and Orderable Information	16

4 Revision History

Changes from Revision B (July 2007) to Revision C

Page

• Changed format to meet latest data sheet standards; added new sections, and moved existing sections	1
• Added bullet item for DDC package to Features list	1
• Revised <i>Device Information</i> table to include SOT-5 package.....	1
• Updated <i>Typical Application Circuit</i> to show SOT-5 (DDC) package pin configuration	1
• Added pin configuration drawings	3
• Deleted <i>Dissipation Ratings</i> table; see Thermal Information	4
• Changed y-axis title in Figure 11 to <i>Feedback Current</i> from <i>Supply Current</i>	6
• Reworded second paragraph in Current Limit subsection.	12

Changes from Revision A (June 2007) to Revision B

Page

• Added second paragraph in Current Limit subsection	12
• Changed equation shown in Figure 27	13

Changes from Original (September 2003) to Revision A

Page

• Changed document format to correspond to current product line standards.....	1
• Removed <i>Output Voltage vs Output Current</i> graph (original Fig 2)	6

5 Pin Configuration and Functions

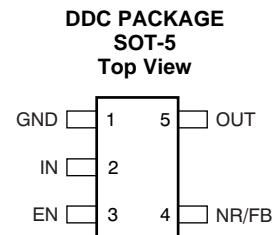
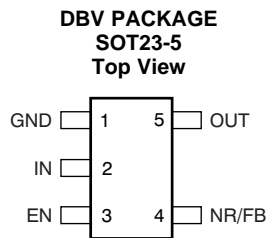

Pin Functions

PIN		I/O	DESCRIPTION
NAME	NO.		
GND	1	—	Ground
IN	2	I	Input supply
EN	3	I	Bipolar enable pin. Driving this pin above the positive enable threshold or below the negative enable threshold turns on the regulator. Driving this pin below the positive disable threshold and above the negative disable threshold puts the regulator into shutdown mode.
NR	4	—	Fixed voltage versions only. Connecting an external capacitor between this pin and ground, bypasses noise generated by the internal bandgap. This configuration allows output noise to be reduced to very low levels.
FB	4	I	Adjustable voltage version only. This pin is the input to the control loop error amplifier. It is used to set the output voltage of the device.
OUT	5	O	Regulated output voltage. A small, 2.2- μ F ceramic capacitor is needed from this pin to GND to ensure stability.

6 Specifications

6.1 Absolute Maximum Ratings

over operating junction temperature range (unless otherwise noted)⁽¹⁾⁽²⁾

		MIN	MAX	UNIT
Voltage	IN	-11	+0.3	V
	NR	-11	+5.5	V
	EN	-V _I	+5.5	V
	OUT	-11	+0.3	V
Current	OUT	Internally limited		A
Output short-circuit duration		Indefinite		
Continuous total power dissipation		See Thermal Information table		
Operating junction temperature, T _J		-65	150	°C

- (1) Stresses beyond those listed under *Absolute Maximum Ratings* may cause permanent damage to the device. These are stress ratings only, which do not imply functional operation of the device at these or any other conditions beyond those indicated under *Recommended Operating Conditions*. Exposure to absolute-maximum-rated conditions for extended periods may affect device reliability.
- (2) All voltage values are with respect to network ground terminal.

6.2 Handling Ratings

		MIN	MAX	UNIT	
T _{stg}	Storage temperature range	-65	150	°C	
V _(ESD)	Electrostatic discharge	Human body model (HBM), per ANSI/ESDA/JEDEC JS-001, all pins	-1000	1000	V
		Charged device model (CDM), per JEDEC specification JESD22-C101, all pins	-500	500	

6.3 Recommended Operating Conditions

over operating junction temperature range (unless otherwise noted)

		MIN	NOM	MAX	UNIT
V _I	Input supply voltage range	-10		-2.7	V
I _O	Output current	0		200	mA
T _J	Operating junction temperature	-40		125	°C

6.4 Thermal Information

THERMAL METRIC ⁽¹⁾		TPS723xx		UNIT
		DBV	DDC	
		5 PINS	5 PINS	
R _{θJA}	Junction-to-ambient thermal resistance	206.9	194.8	°C/W
R _{θJC(top)}	Junction-to-case (top) thermal resistance	120.5	41.4	
R _{θJB}	Junction-to-board thermal resistance	35.9	35.9	
ψ _{JT}	Junction-to-top characterization parameter	13.3	1.0	
ψ _{JB}	Junction-to-board characterization parameter	35.0	35.7	
R _{θJC(bot)}	Junction-to-case (bottom) thermal resistance	N/A	N/A	

- (1) For more information about traditional and new thermal metrics, see the *IC Package Thermal Metrics* application report, [SPRA953](#).

6.5 Electrical Characteristics

Over operating junction temperature range, $V_I = V_{O(NOM)} - 0.5\text{ V}$, $I_O = 1\text{ mA}$, $V_{EN} = 1.5\text{ V}$, $C_O = 2.2\text{ }\mu\text{F}$, and $C_{NR} = 0.01\text{ }\mu\text{F}$, unless otherwise noted. Typical values are at $T_J = 25^\circ\text{C}$.

PARAMETER		TEST CONDITIONS	TPS723xx			UNIT
			MIN	TYP	MAX	
V_I	Input voltage range ⁽¹⁾		-10		-2.7	V
V_{FB}	Feedback reference voltage	TPS72301 $T_J = 25^\circ\text{C}$	-1.210	-1.186	-1.162	V
V_O	Output voltage range	TPS72301	$-10 + V_{DO}$		V_{FB}	V
	Accuracy	Nominal	$T_J = 25^\circ\text{C}$			
		TPS72325 vs $V_I/I_O/T$	$-10\text{ V} \leq V_I \leq V_O - 0.5\text{ V}$, $10\text{ }\mu\text{A} \leq I_O \leq 200\text{ mA}$		-2%	$\pm 1\%$
	TPS72301 vs $V_I/I_O/T$			-3%	± 1	3%
$\Delta V_{O(\Delta V_I)}$	Line regulation	$-10\text{ V} \leq V_I \leq V_{O(NOM)} - 0.5\text{ V}$	0.04			%/V
$\Delta V_{O(\Delta I_O)}$	Load regulation	$0\text{ mA} \leq I_O \leq 200\text{ mA}$	0.002			%/mA
V_{DO}	Dropout voltage at $V_O = 0.96 \times V_{O(NOM)}$	TPS72325	$I_O = 200\text{ mA}$		280 500	mV
$I_{(LIM)}$	Current limit	$V_O = 0.85 \times V_{O(NOM)}$	300	550	800	mA
$I_{(GND)}$	Ground pin current	$I_O = 0\text{ mA}$ (I_O), $-10\text{ V} \leq V_I \leq V_O - 0.5\text{ V}$	130		200	μA
		$I_O = 200\text{ mA}$, $-10\text{ V} \leq V_I \leq V_O - 0.5\text{ V}$	350		500	
$I_{(SHDN)}$	Shutdown ground pin current	$-0.4\text{ V} \leq V_{EN} \leq 0.4\text{ V}$, $-10\text{ V} \leq V_I \leq V_O - 0.5\text{ V}$	0.1		2.0	μA
$I_{(FB)}$	Feedback pin current	$-10\text{ V} \leq V_I \leq V_O - 0.5\text{ V}$	0.05		1.0	μA
PSRR	Power-supply rejection ratio	TPS72325	$I_O = 200\text{ mA}$, 1 kHz, $C_I = C_O = 10\text{ }\mu\text{F}$		65	dB
			$I_O = 200\text{ mA}$, 10 kHz, $C_I = C_O = 10\text{ }\mu\text{F}$		48	
V_n	Output noise voltage	TPS72325	$C_O = 10\text{ }\mu\text{F}$, 10 Hz to 100 kHz, $I_O = 200\text{ mA}$		60	μV_{RMS}
t_{STR}	Startup time	$V_O = -2.5\text{ V}$, $C_O = 1\text{ }\mu\text{F}$, $R_L = 25\text{ }\Omega$	1			ms
$V_{EN(HI)}$	Enable threshold positive		1.5			V
$V_{EN(LO)}$	Enable threshold negative				-1.5	V
$V_{DIS(HI)}$	Disable threshold positive				0.4	V
$V_{DIS(LO)}$	Disable threshold negative		-0.4			V
$I_{(EN)}$	Enable pin current	$-10\text{ V} \leq V_I \leq V_O - 0.5\text{ V}$, $-10\text{ V} \leq V_{EN} \leq \pm 3.5\text{ V}$	0.1		2.0	μA
T_{sd}	Thermal shutdown temperature	Shutdown, temperature increasing	165			$^\circ\text{C}$
		Reset, temperature decreasing	145			
T_J	Operating junction temperature		-40		125	$^\circ\text{C}$

(1) Maximum $V_I = (V_O - V_{DO})$ or -2.7 V , whichever is more negative.

6.6 Typical Characteristics

TPS72325 at $V_I = V_{O(NOM)} - 0.5\text{ V}$, $I_O = 1\text{ mA}$, $V_{EN} = 1.5\text{ V}$, $C_O = 2.2\text{ }\mu\text{F}$, and $C_{NR} = 0.01\text{ }\mu\text{F}$, unless otherwise noted.

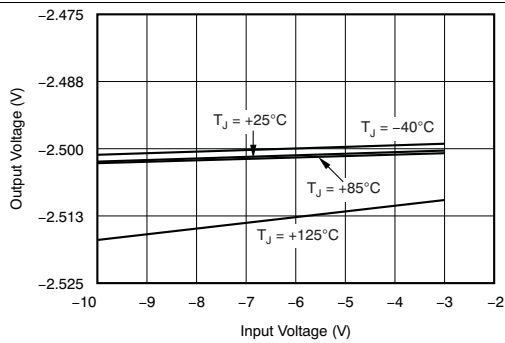

Figure 1. Output Voltage vs Input Voltage

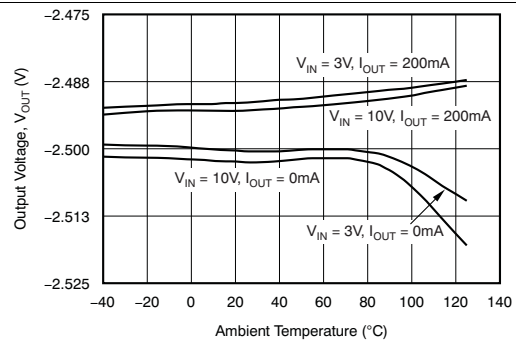

Figure 2. Output Voltage vs Ambient Temperature

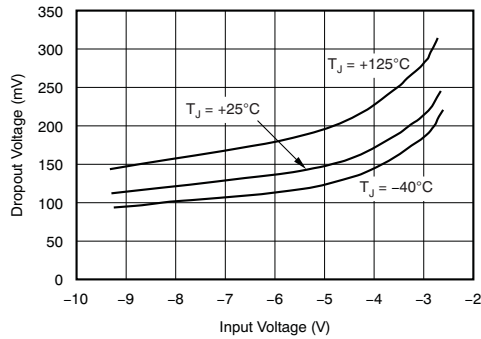

Figure 3. TPS72301 Dropout Voltage vs Input Voltage

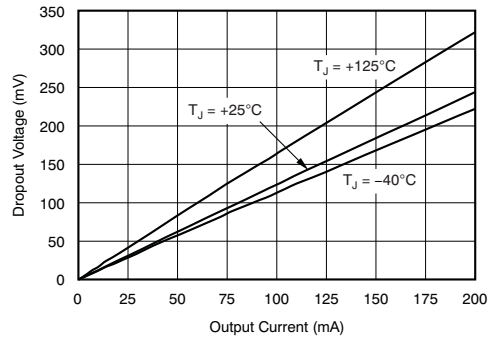

Figure 4. Dropout Voltage vs Output Current

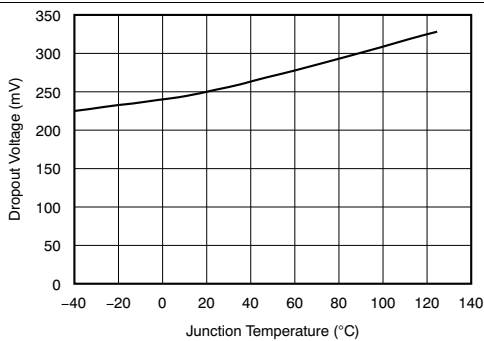

Figure 5. TPS72325 Dropout Voltage vs Junction Temperature

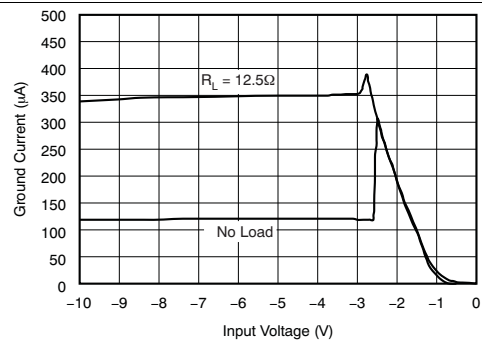

Figure 6. Ground Current vs Input Voltage

Typical Characteristics (continued)

TPS72325 at $V_I = V_{O(NOM)} - 0.5\text{ V}$, $I_O = 1\text{ mA}$, $V_{EN} = 1.5\text{ V}$, $C_O = 2.2\text{ }\mu\text{F}$, and $C_{NR} = 0.01\text{ }\mu\text{F}$, unless otherwise noted.

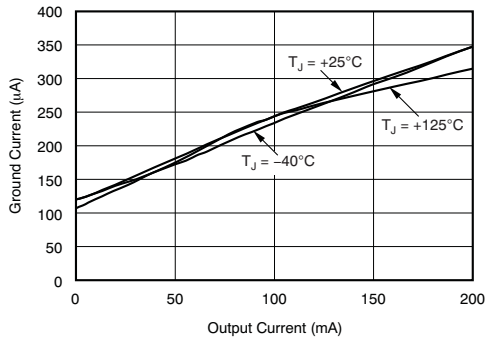

Figure 7. Ground Current vs Output Current

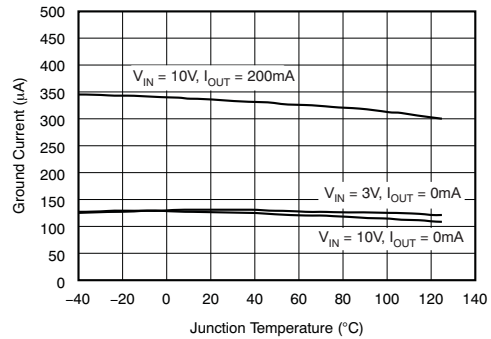

Figure 8. Ground Current vs Junction Temperature

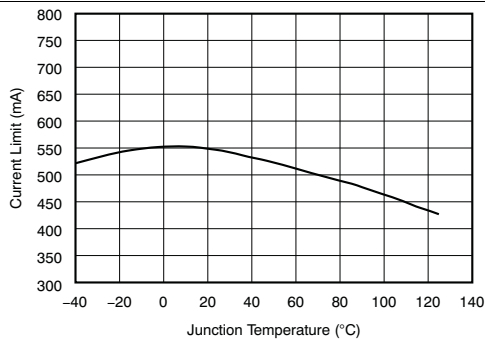

Figure 9. TPS72325 Current Limit vs Junction Temperature

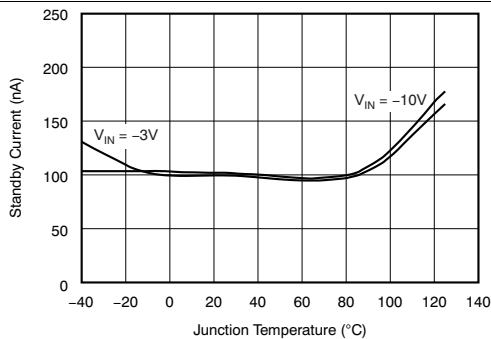

Figure 10. Standby Current vs Junction Temperature

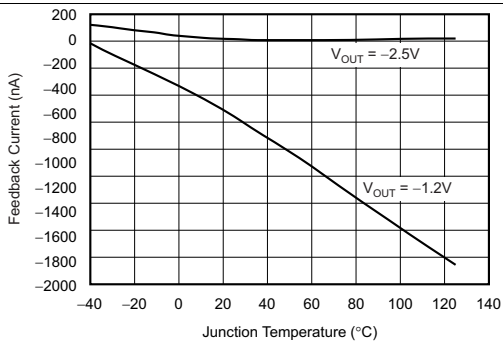

Figure 11. TPS72301 Feedback Pin Current vs Junction Temperature

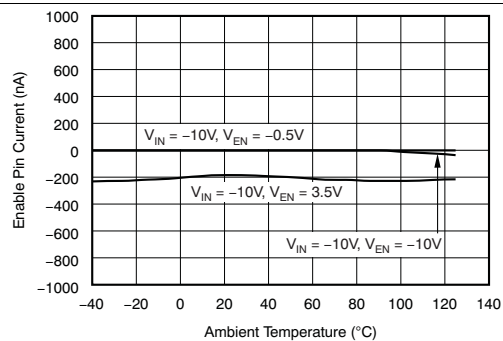

Figure 12. Enable Pin Current vs Junction Temperature

Typical Characteristics (continued)

TPS72325 at $V_I = V_{O(NOM)} - 0.5\text{ V}$, $I_O = 1\text{ mA}$, $V_{EN} = 1.5\text{ V}$, $C_O = 2.2\text{ }\mu\text{F}$, and $C_{NR} = 0.01\text{ }\mu\text{F}$, unless otherwise noted.

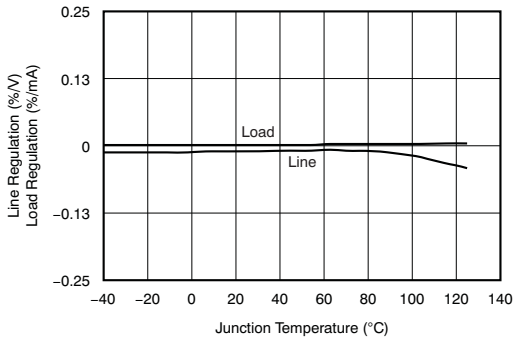

Figure 13. Line And Load Regulation vs Junction Temperature

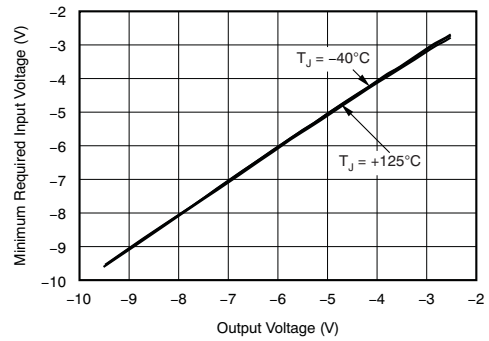

Figure 14. TPS72301 Minimum Required Input Voltage vs Output Voltage

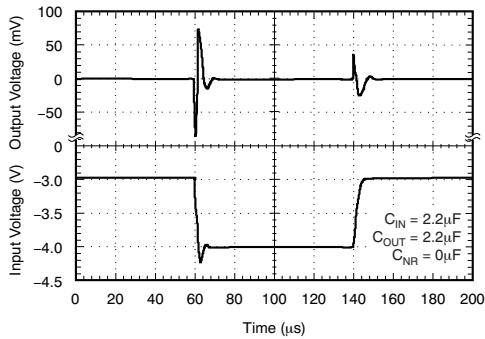

Figure 15. TPS72325 Line Transient Response

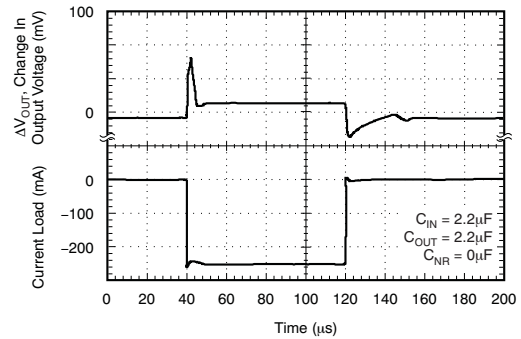

Figure 16. TPS72325 Load Transient Response

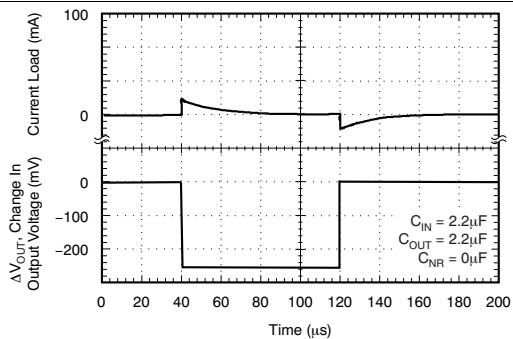

Figure 17. TPS72325 Load Transient Response

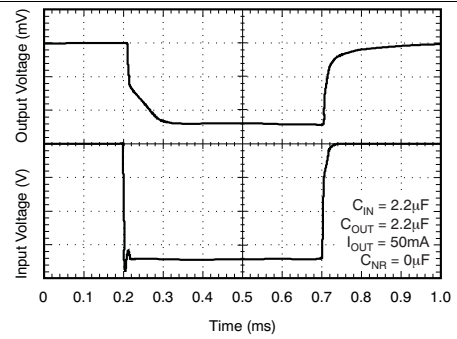

Figure 18. TPS72325 Start-Up Response

Typical Characteristics (continued)

TPS72325 at $V_I = V_{O(NOM)} - 0.5\text{ V}$, $I_O = 1\text{ mA}$, $V_{EN} = 1.5\text{ V}$, $C_O = 2.2\text{ }\mu\text{F}$, and $C_{NR} = 0.01\text{ }\mu\text{F}$, unless otherwise noted.

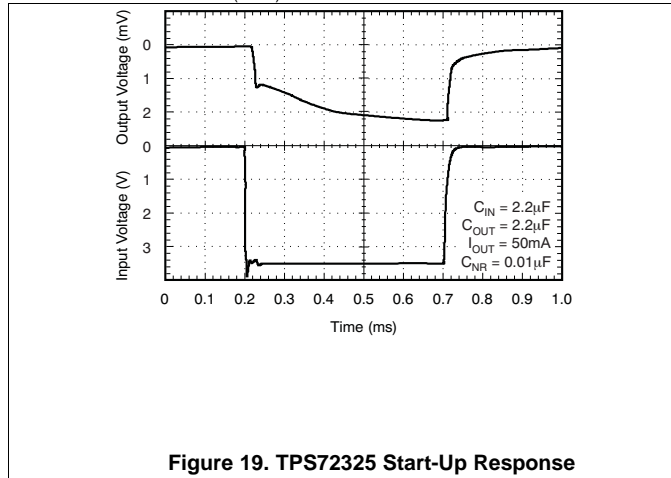

Figure 19. TPS72325 Start-Up Response

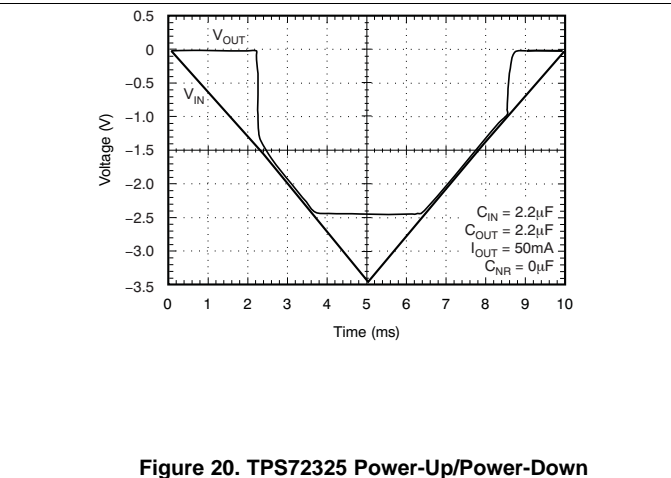

Figure 20. TPS72325 Power-Up/Power-Down

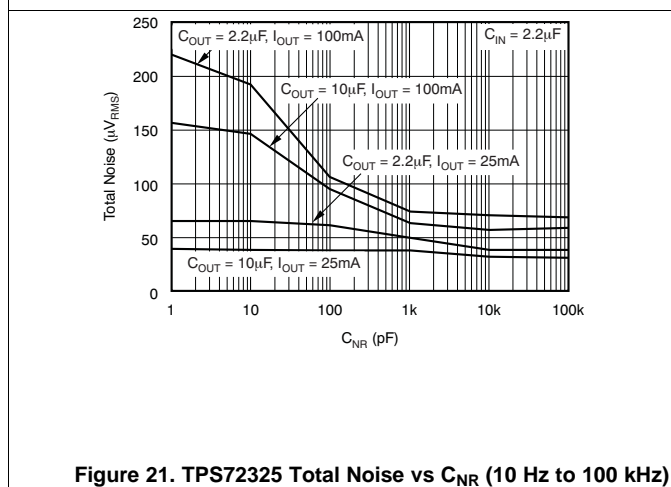

Figure 21. TPS72325 Total Noise vs C_{NR} (10 Hz to 100 kHz)

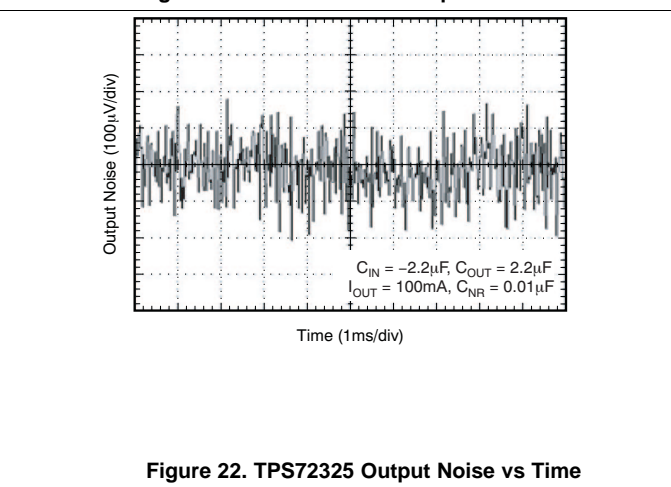

Figure 22. TPS72325 Output Noise vs Time

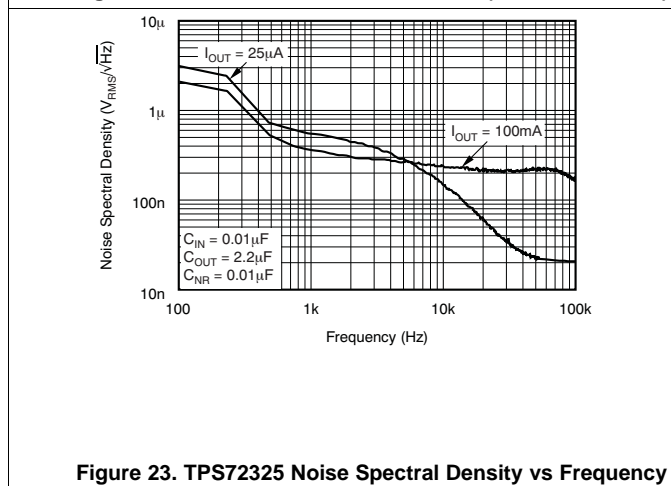

Figure 23. TPS72325 Noise Spectral Density vs Frequency

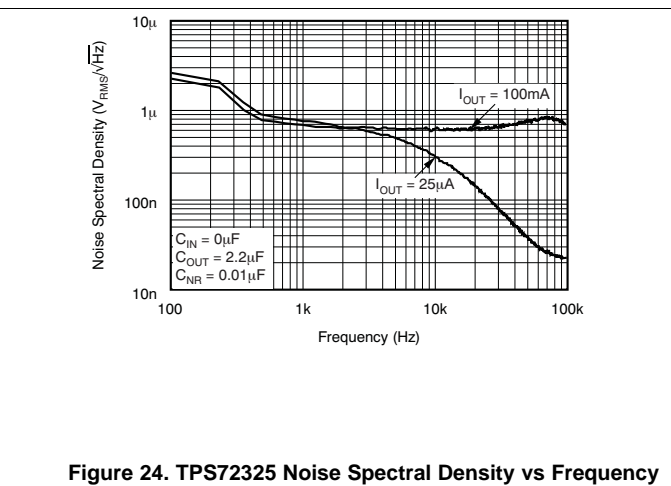

Figure 24. TPS72325 Noise Spectral Density vs Frequency

Typical Characteristics (continued)

TPS72325 at $V_I = V_{O(NOM)} - 0.5\text{ V}$, $I_O = 1\text{ mA}$, $V_{EN} = 1.5\text{ V}$, $C_O = 2.2\text{ }\mu\text{F}$, and $C_{NR} = 0.01\text{ }\mu\text{F}$, unless otherwise noted.

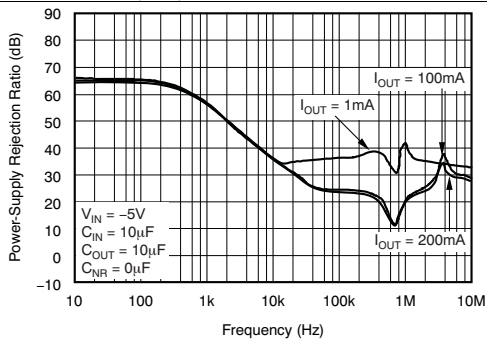

Figure 25. PSRR vs Frequency

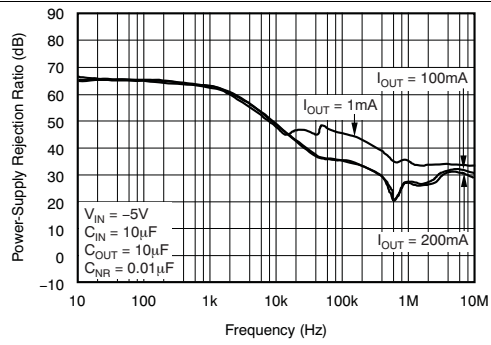

Figure 26. PSRR vs Frequency

7 Detailed Description

7.1 Overview

The TPS723xx is a low-dropout, negative linear voltage regulator with a rated current of 200 mA. It is offered in trimmed output voltages between -1.5 V and -5.2 V and as an adjustable regulator from -1.2 V to -10 V . It features very low noise and high power-supply rejection ratio (PSRR), making it ideal for high-sensitivity analog and RF applications. A shutdown mode is available, reducing ground current to $2\text{ }\mu\text{A}$ maximum over temperature and process.

7.2 Functional Block Diagrams

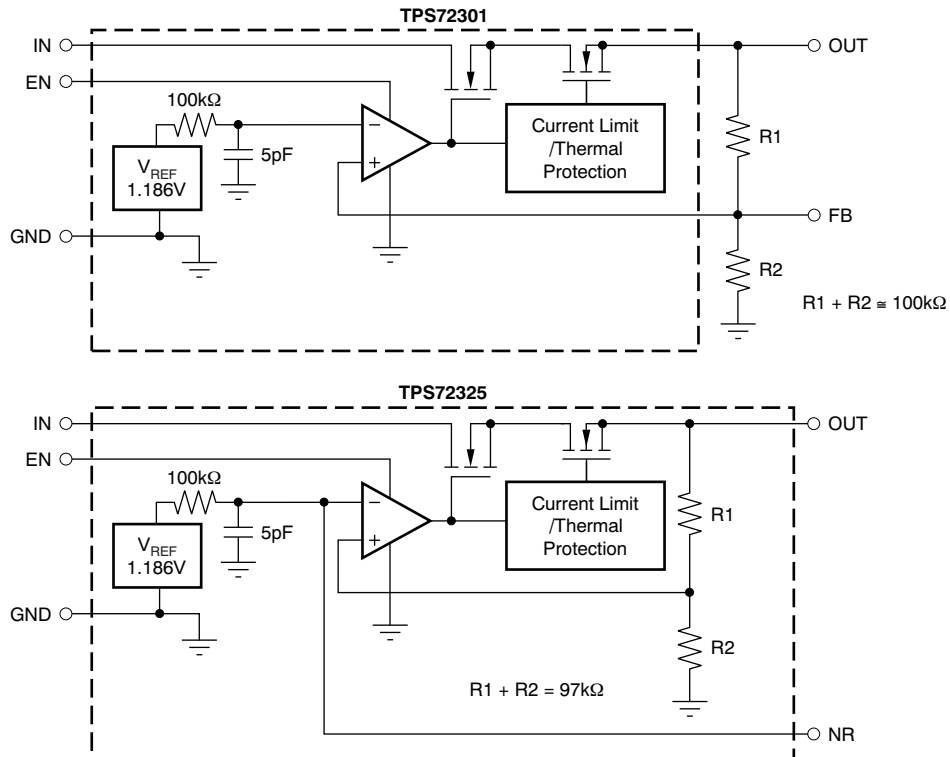

7.3 Feature Description

7.3.1 Current Limit

The TPS723xx has internal circuitry that monitors and limits output current to protect the regulator from damage under all load conditions. When output current reaches the output current limit (550 mA typical), protection circuitry turns on, reducing output voltage to ensure that current does not increase. See [Figure 9](#) in the [Typical Characteristics](#) section.

Do not drive the output more than 0.3 V above the input. An output voltage more than 0.3 V above the input voltage biases the body diode in the pass FET, and allows current to flow from the output to the input. This current is not limited by the device. If this condition is expected, make sure to externally limit the reverse current.

7.3.2 Enable

The enable pin is active above +1.5 V and below –1.5 V, allowing it to be controlled by a standard TTL signal or by connection to V_I if not used. When driven to GND most internal circuitry is turned off, putting the TPS723xx into shutdown mode, drawing 2- μ A maximum ground current.

7.4 Device Functional Modes

Driving EN over 1.5 V or below –1.5 V turns on the regulator. Driving EN between –1.5 V and +1.5 V puts the regulator into shutdown mode, thus reducing the operating current to 100 nA, nominal.

8 Application and Implementation

NOTE

Information in the following applications sections is not part of the TI component specification, and TI does not warrant its accuracy or completeness. TI's customers are responsible for determining suitability of components for their purposes. Customers should validate and test their design implementation to confirm system functionality.

8.1 Application Information

The TPS723xx family of LDO regulators provides high PSRR and low noise. These features make the family a good fit for high-sensitivity analog and RF applications.

8.2 Typical Application

The TPS72301 allows designers to specify any output voltage from -10 V to -1.2 V . As shown in the application circuit in [Figure 27](#), an external resistor divider is used to scale the output voltage (V_O) to the reference voltage. For best accuracy, use precision resistors for R1 and R2. Use the equations in [Figure 27](#) to determine the values for the resistor divider.

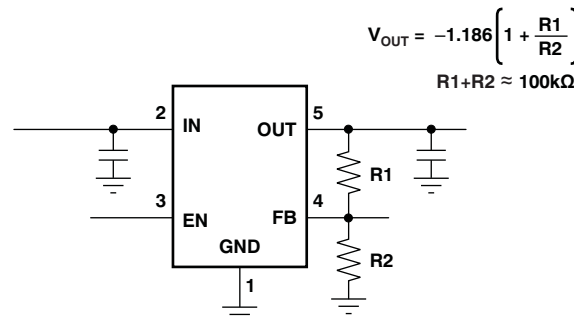

Figure 27. TPS72301 Adjustable LDO Regulator Programming

8.2.1 Design Requirements

8.2.1.1 Capacitor Selection for Stability

Appropriate input and output capacitors should be used for the intended application. The TPS723xx only requires a 2.2- μF ceramic output capacitor to be used for stable operation. Both the capacitor value and equivalent series resistance (ESR) affect stability, output noise, PSRR, and transient response. For typical applications, a 2.2- μF ceramic output capacitor located close to the regulator is sufficient.

8.2.1.2 Output Noise

Without external bypassing, output noise of the TPS723xx from 10 Hz to 100 kHz is 200 μV_{RMS} typical. The dominant contributor to output noise is the internal bandgap reference. Adding an external 0.01- μF capacitor to ground reduces noise to 60 μV_{RMS} . Best noise performance is achieved using appropriate low ESR capacitors for bypassing noise at the IN and OUT pins. See [Figure 21](#) in the *Typical Characteristics* section.

8.2.1.3 Power-Supply Rejection

The TPS723xx offers a very high PSRR for applications with noisy input sources or highly sensitive output supply lines. For best PSRR, use high-quality input and output capacitors.

8.2.2 Detailed Design Procedure

Select the desired device based on the output voltage.

Provide an input supply with adequate headroom to account for dropout and output current to account for the GND terminal current, and power the load.

Typical Application (continued)

8.2.3 Application Curves

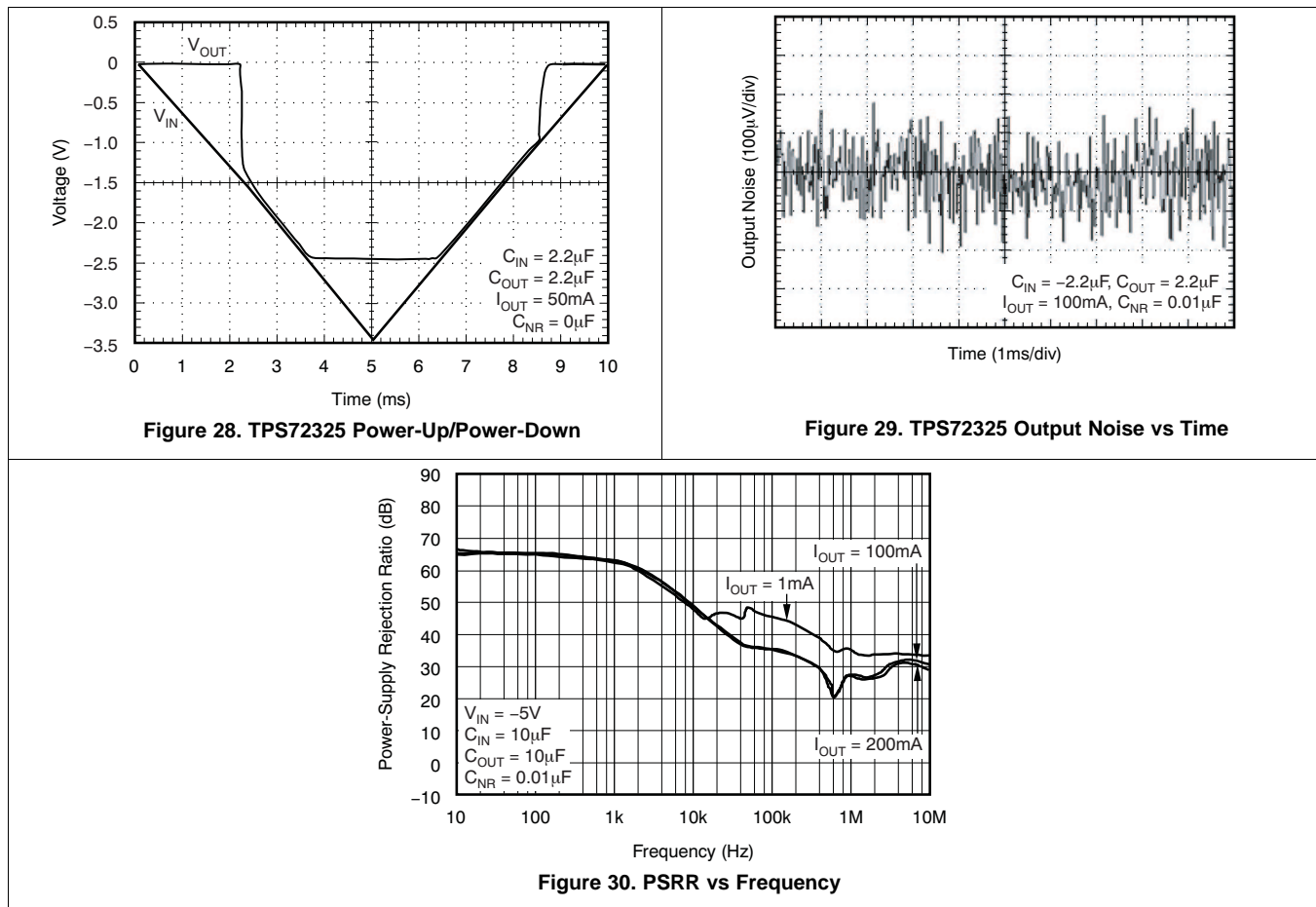

8.3 Do's and Don'ts

- Do place at least one 2.2- μF ceramic capacitor as close as possible to the OUT terminal of the regulator.
- Do not place the output capacitor more than 10 mm away from the regulator.
- Do connect a 0.1- μF to 2.2- μF low ESR capacitor across the IN terminal and GND input of the regulator.
- Do not exceed the absolute maximum ratings.

9 Power-Supply Recommendations

These devices are designed to operate from an input voltage supply range between -10 V and -2.7 V . The input voltage range must provide adequate headroom in order for the device to have a regulated output. This input supply must be well-regulated and stable. If the input supply is noisy, additional input capacitors with low ESR can help improve the output noise performance.

10 Layout

10.1 Layout Guidelines

To improve ac performance (such as PSRR, output noise, and transient response), design the board with separate ground planes for V_I and V_O , with each ground plane connected only at the GND pin of the device. In addition, connect the bypass capacitor directly to the GND pin of the device.

10.2 Layout Example

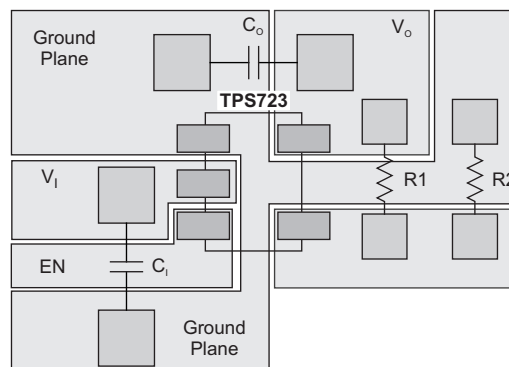

Figure 31. Example Layout

10.3 Power Dissipation

The ability to remove heat from the die is different for each package type, presenting different considerations in the printed circuit board (PCB) layout. The PCB area around the device that is free of other components moves the heat from the device to the ambient air. Performance data for JEDEC low- and high-K boards are given in the [Thermal Information](#) table near the front of this data sheet. Using heavier copper increases the effectiveness in removing heat from the device. The addition of plated through-holes to heat-dissipating layers also improves heatsink effectiveness. Power dissipation depends on input voltage and load conditions. Power dissipation is equal to the product of the output current times the voltage drop across the output pass element, as shown in [Equation 1](#):

$$P_D = (V_{IN} - V_{OUT}) \cdot I_{OUT} \quad (1)$$

10.4 Thermal Protection

As protection from damage due to excessive junction temperatures, the TPS723xx has internal protection circuitry. When junction temperature reaches approximately 165°C , the output device is turned off. After the device has cooled to 145°C , the output device is enabled, allowing normal operation. For reliable operation, design is for worst-case junction temperature of $\leq 125^\circ\text{C}$ taking into account worst-case ambient temperature and load conditions.

11 Device and Documentation Support

11.1 Device Support

11.1.1 Development Support

11.1.1.1 Spice Models

Computer simulation of circuit performance using SPICE is often useful when analyzing the performance of analog circuits and systems. A SPICE model for the TPS723xx is available through the product folders under *Simulation Models*.

11.1.2 Device Nomenclature

Table 1. Device Nomenclature⁽¹⁾

PRODUCT	V _{OUT}
TPS723xx yyy z	XX is nominal output voltage (for example, 25 = 2.5 V, 01 = Adjustable). YYY is package designator. Z is package quantity.

(1) For the most current package and ordering information see the Package Option Addendum at the end of this document, or visit the device product folder at www.ti.com.

11.2 Related Links

The table below lists quick access links. Categories include technical documents, support and community resources, tools and software, and quick access to sample or buy.

Table 2. Related Links

PARTS	PRODUCT FOLDER	SAMPLE & BUY	TECHNICAL DOCUMENTS	TOOLS & SOFTWARE	SUPPORT & COMMUNITY
TPS72301	Click here	Click here	Click here	Click here	Click here
TPS72325	Click here	Click here	Click here	Click here	Click here

11.3 Trademarks

All trademarks are the property of their respective owners.

11.4 Electrostatic Discharge Caution



These devices have limited built-in ESD protection. The leads should be shorted together or the device placed in conductive foam during storage or handling to prevent electrostatic damage to the MOS gates.

11.5 Glossary

[SLYZ022](#) — *TI Glossary*.

This glossary lists and explains terms, acronyms, and definitions.

12 Mechanical, Packaging, and Orderable Information

The following pages include mechanical, packaging, and orderable information. This information is the most current data available for the designated devices. This data is subject to change without notice and revision of this document. For browser-based versions of this data sheet, refer to the left-hand navigation.

PACKAGING INFORMATION

Orderable Device	Status (1)	Package Type	Package Drawing	Pins	Package Qty	Eco Plan (2)	Lead/Ball Finish (6)	MSL Peak Temp (3)	Op Temp (°C)	Device Marking (4/5)	Samples
TPS72301DBVR	ACTIVE	SOT-23	DBV	5	3000	Green (RoHS & no Sb/Br)	CU NIPDAU	Level-1-260C-UNLIM	-40 to 125	T08I	Samples
TPS72301DBVRG4	ACTIVE	SOT-23	DBV	5	3000	Green (RoHS & no Sb/Br)	CU NIPDAU	Level-1-260C-UNLIM	-40 to 125	T08I	Samples
TPS72301DBVT	ACTIVE	SOT-23	DBV	5	250	Green (RoHS & no Sb/Br)	CU NIPDAU	Level-1-260C-UNLIM	-40 to 125	T08I	Samples
TPS72301DBVTG4	ACTIVE	SOT-23	DBV	5	250	Green (RoHS & no Sb/Br)	CU NIPDAU	Level-1-260C-UNLIM	-40 to 125	T08I	Samples
TPS72301DDCR	ACTIVE	SOT	DDC	5	3000	Green (RoHS & no Sb/Br)	CU NIPDAU	Level-2-260C-1 YEAR	-40 to 125	T08I	Samples
TPS72301DDCT	ACTIVE	SOT	DDC	5	250	Green (RoHS & no Sb/Br)	CU NIPDAU	Level-2-260C-1 YEAR	-40 to 125	T08I	Samples
TPS72325DBVR	ACTIVE	SOT-23	DBV	5	3000	Green (RoHS & no Sb/Br)	CU NIPDAU	Level-1-260C-UNLIM	-40 to 125	T02I	Samples
TPS72325DBVRG4	ACTIVE	SOT-23	DBV	5	3000	Green (RoHS & no Sb/Br)	CU NIPDAU	Level-1-260C-UNLIM	-40 to 125	T02I	Samples
TPS72325DBVT	ACTIVE	SOT-23	DBV	5	250	Green (RoHS & no Sb/Br)	CU NIPDAU	Level-1-260C-UNLIM	-40 to 125	T02I	Samples
TPS72325DBVTG4	ACTIVE	SOT-23	DBV	5	250	Green (RoHS & no Sb/Br)	CU NIPDAU	Level-1-260C-UNLIM	-40 to 125	T02I	Samples

(1) The marketing status values are defined as follows:

ACTIVE: Product device recommended for new designs.

LIFEBUY: TI has announced that the device will be discontinued, and a lifetime-buy period is in effect.

NRND: Not recommended for new designs. Device is in production to support existing customers, but TI does not recommend using this part in a new design.

PREVIEW: Device has been announced but is not in production. Samples may or may not be available.

OBSOLETE: TI has discontinued the production of the device.

(2) Eco Plan - The planned eco-friendly classification: Pb-Free (RoHS), Pb-Free (RoHS Exempt), or Green (RoHS & no Sb/Br) - please check <http://www.ti.com/productcontent> for the latest availability information and additional product content details.

TBD: The Pb-Free/Green conversion plan has not been defined.

Pb-Free (RoHS): TI's terms "Lead-Free" or "Pb-Free" mean semiconductor products that are compatible with the current RoHS requirements for all 6 substances, including the requirement that lead not exceed 0.1% by weight in homogeneous materials. Where designed to be soldered at high temperatures, TI Pb-Free products are suitable for use in specified lead-free processes.

Pb-Free (RoHS Exempt): This component has a RoHS exemption for either 1) lead-based flip-chip solder bumps used between the die and package, or 2) lead-based die adhesive used between the die and leadframe. The component is otherwise considered Pb-Free (RoHS compatible) as defined above.

Green (RoHS & no Sb/Br): TI defines "Green" to mean Pb-Free (RoHS compatible), and free of Bromine (Br) and Antimony (Sb) based flame retardants (Br or Sb do not exceed 0.1% by weight in homogeneous material)

- (3) MSL, Peak Temp. - The Moisture Sensitivity Level rating according to the JEDEC industry standard classifications, and peak solder temperature.
- (4) There may be additional marking, which relates to the logo, the lot trace code information, or the environmental category on the device.
- (5) Multiple Device Markings will be inside parentheses. Only one Device Marking contained in parentheses and separated by a "~" will appear on a device. If a line is indented then it is a continuation of the previous line and the two combined represent the entire Device Marking for that device.
- (6) Lead/Ball Finish - Orderable Devices may have multiple material finish options. Finish options are separated by a vertical ruled line. Lead/Ball Finish values may wrap to two lines if the finish value exceeds the maximum column width.

Important Information and Disclaimer:The information provided on this page represents TI's knowledge and belief as of the date that it is provided. TI bases its knowledge and belief on information provided by third parties, and makes no representation or warranty as to the accuracy of such information. Efforts are underway to better integrate information from third parties. TI has taken and continues to take reasonable steps to provide representative and accurate information but may not have conducted destructive testing or chemical analysis on incoming materials and chemicals. TI and TI suppliers consider certain information to be proprietary, and thus CAS numbers and other limited information may not be available for release.

In no event shall TI's liability arising out of such information exceed the total purchase price of the TI part(s) at issue in this document sold by TI to Customer on an annual basis.

OTHER QUALIFIED VERSIONS OF TPS72301, TPS72325 :

- Automotive: [TPS72301-Q1](#), [TPS72325-Q1](#)

NOTE: Qualified Version Definitions:

- Automotive - Q100 devices qualified for high-reliability automotive applications targeting zero defects

TAPE AND REEL INFORMATION

QUADRANT ASSIGNMENTS FOR PIN 1 ORIENTATION IN TAPE

*All dimensions are nominal

Device	Package Type	Package Drawing	Pins	SPQ	Reel Diameter (mm)	Reel Width W1 (mm)	A0 (mm)	B0 (mm)	K0 (mm)	P1 (mm)	W (mm)	Pin1 Quadrant
TPS72301DBVR	SOT-23	DBV	5	3000	179.0	8.4	3.2	3.2	1.4	4.0	8.0	Q3
TPS72301DBVT	SOT-23	DBV	5	250	179.0	8.4	3.2	3.2	1.4	4.0	8.0	Q3
TPS72301DDCR	SOT	DDC	5	3000	179.0	8.4	3.2	3.2	1.4	4.0	8.0	Q3
TPS72301DDCT	SOT	DDC	5	250	179.0	8.4	3.2	3.2	1.4	4.0	8.0	Q3
TPS72325DBVR	SOT-23	DBV	5	3000	179.0	8.4	3.2	3.2	1.4	4.0	8.0	Q3
TPS72325DBVT	SOT-23	DBV	5	250	179.0	8.4	3.2	3.2	1.4	4.0	8.0	Q3

TAPE AND REEL BOX DIMENSIONS

*All dimensions are nominal

Device	Package Type	Package Drawing	Pins	SPQ	Length (mm)	Width (mm)	Height (mm)
TPS72301DBVR	SOT-23	DBV	5	3000	203.0	203.0	35.0
TPS72301DBVT	SOT-23	DBV	5	250	203.0	203.0	35.0
TPS72301DDCR	SOT	DDC	5	3000	195.0	200.0	45.0
TPS72301DDCT	SOT	DDC	5	250	195.0	200.0	45.0
TPS72325DBVR	SOT-23	DBV	5	3000	203.0	203.0	35.0
TPS72325DBVT	SOT-23	DBV	5	250	203.0	203.0	35.0

DBV (R-PDSO-G5)

PLASTIC SMALL-OUTLINE PACKAGE



4073253-4/L 08/2013

- NOTES:
- All linear dimensions are in millimeters.
 - This drawing is subject to change without notice.
 - Body dimensions do not include mold flash or protrusion. Mold flash and protrusion shall not exceed 0.15 per side.
 - Falls within JEDEC MO-178 Variation AA.

DBV (R-PDSO-G5)

PLASTIC SMALL OUTLINE



- NOTES:
- A. All linear dimensions are in millimeters.
 - B. This drawing is subject to change without notice.
 - C. Customers should place a note on the circuit board fabrication drawing not to alter the center solder mask defined pad.
 - D. Publication IPC-7351 is recommended for alternate designs.
 - E. Laser cutting apertures with trapezoidal walls and also rounding corners will offer better paste release. Customers should contact their board assembly site for stencil design recommendations. Example stencil design based on a 50% volumetric metal load solder paste. Refer to IPC-7525 for other stencil recommendations.

DDC (R-PDSO-G5)

PLASTIC SMALL-OUTLINE

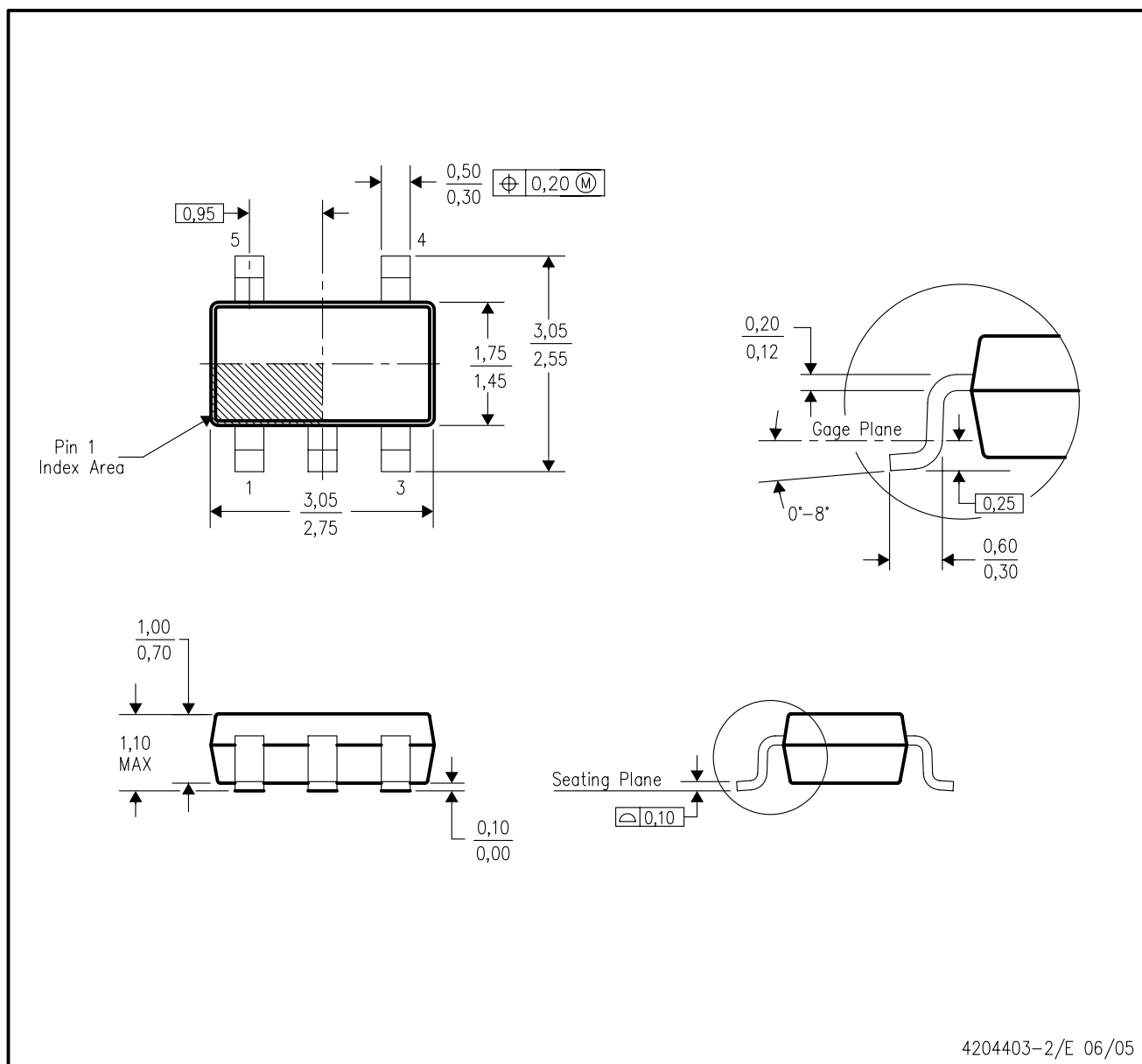

- NOTES:
- All linear dimensions are in millimeters.
 - This drawing is subject to change without notice.
 - Body dimensions do not include mold flash or protrusion.
 - Falls within JEDEC MO-193 variation AB (5 pin).

DDC (R-PDSO-G5)

PLASTIC SMALL OUTLINE

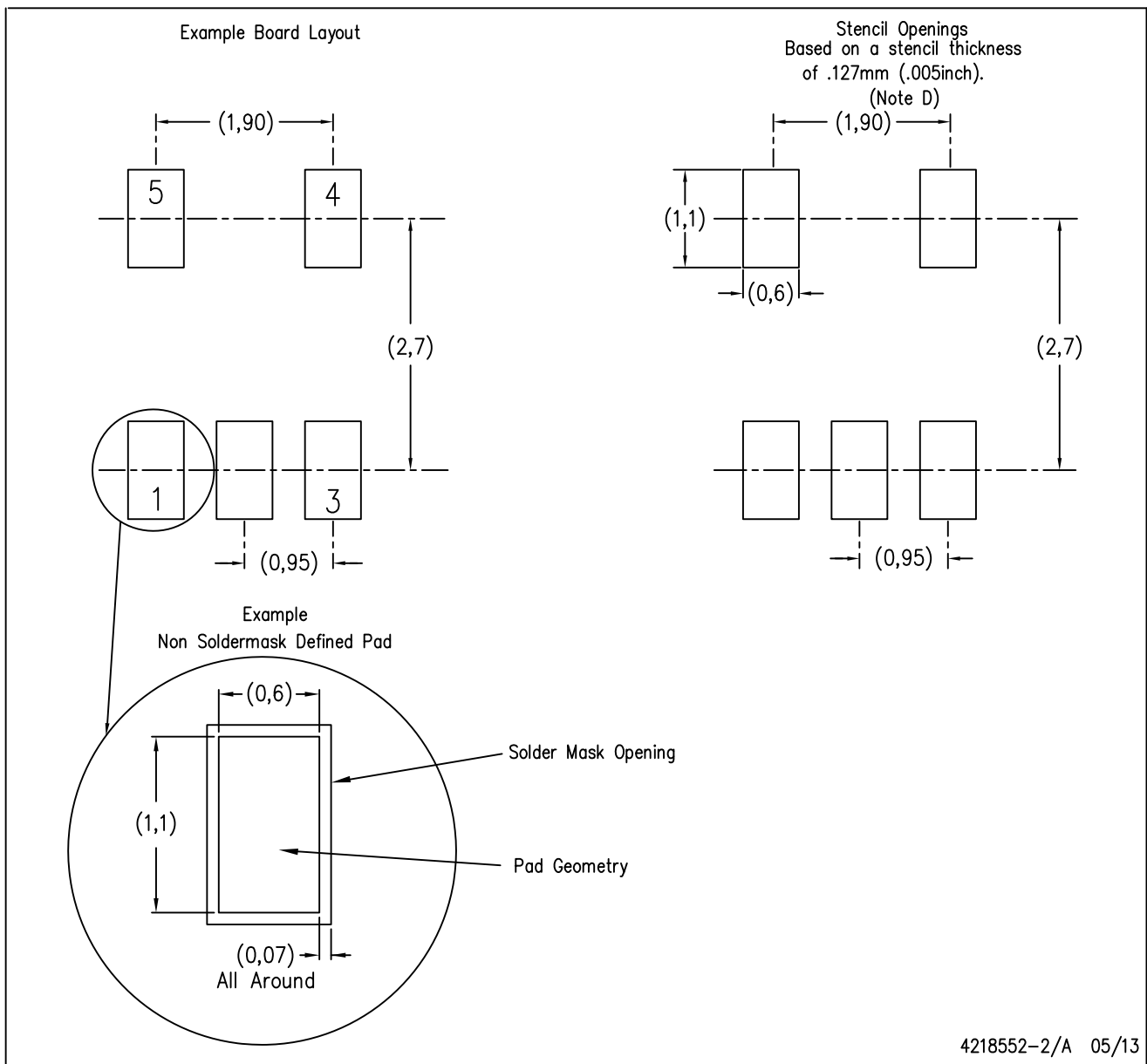

- NOTES:
- A. All linear dimensions are in millimeters.
 - B. This drawing is subject to change without notice.
 - C. Publication IPC-7351 is recommended for alternate designs.
 - D. Laser cutting apertures with trapezoidal walls and also rounding corners will offer better paste release. Customers should contact their board assembly site for stencil design recommendations. Example stencil design based on a 50% volumetric metal load solder paste. Refer to IPC-7525 for other stencil recommendations.

IMPORTANT NOTICE

Texas Instruments Incorporated and its subsidiaries (TI) reserve the right to make corrections, enhancements, improvements and other changes to its semiconductor products and services per JESD46, latest issue, and to discontinue any product or service per JESD48, latest issue. Buyers should obtain the latest relevant information before placing orders and should verify that such information is current and complete. All semiconductor products (also referred to herein as "components") are sold subject to TI's terms and conditions of sale supplied at the time of order acknowledgment.

TI warrants performance of its components to the specifications applicable at the time of sale, in accordance with the warranty in TI's terms and conditions of sale of semiconductor products. Testing and other quality control techniques are used to the extent TI deems necessary to support this warranty. Except where mandated by applicable law, testing of all parameters of each component is not necessarily performed.

TI assumes no liability for applications assistance or the design of Buyers' products. Buyers are responsible for their products and applications using TI components. To minimize the risks associated with Buyers' products and applications, Buyers should provide adequate design and operating safeguards.

TI does not warrant or represent that any license, either express or implied, is granted under any patent right, copyright, mask work right, or other intellectual property right relating to any combination, machine, or process in which TI components or services are used. Information published by TI regarding third-party products or services does not constitute a license to use such products or services or a warranty or endorsement thereof. Use of such information may require a license from a third party under the patents or other intellectual property of the third party, or a license from TI under the patents or other intellectual property of TI.

Reproduction of significant portions of TI information in TI data books or data sheets is permissible only if reproduction is without alteration and is accompanied by all associated warranties, conditions, limitations, and notices. TI is not responsible or liable for such altered documentation. Information of third parties may be subject to additional restrictions.

Resale of TI components or services with statements different from or beyond the parameters stated by TI for that component or service voids all express and any implied warranties for the associated TI component or service and is an unfair and deceptive business practice. TI is not responsible or liable for any such statements.

Buyer acknowledges and agrees that it is solely responsible for compliance with all legal, regulatory and safety-related requirements concerning its products, and any use of TI components in its applications, notwithstanding any applications-related information or support that may be provided by TI. Buyer represents and agrees that it has all the necessary expertise to create and implement safeguards which anticipate dangerous consequences of failures, monitor failures and their consequences, lessen the likelihood of failures that might cause harm and take appropriate remedial actions. Buyer will fully indemnify TI and its representatives against any damages arising out of the use of any TI components in safety-critical applications.

In some cases, TI components may be promoted specifically to facilitate safety-related applications. With such components, TI's goal is to help enable customers to design and create their own end-product solutions that meet applicable functional safety standards and requirements. Nonetheless, such components are subject to these terms.

No TI components are authorized for use in FDA Class III (or similar life-critical medical equipment) unless authorized officers of the parties have executed a special agreement specifically governing such use.

Only those TI components which TI has specifically designated as military grade or "enhanced plastic" are designed and intended for use in military/aerospace applications or environments. Buyer acknowledges and agrees that any military or aerospace use of TI components which have **not** been so designated is solely at the Buyer's risk, and that Buyer is solely responsible for compliance with all legal and regulatory requirements in connection with such use.

TI has specifically designated certain components as meeting ISO/TS16949 requirements, mainly for automotive use. In any case of use of non-designated products, TI will not be responsible for any failure to meet ISO/TS16949.

Products

Audio	www.ti.com/audio
Amplifiers	amplifier.ti.com
Data Converters	dataconverter.ti.com
DLP® Products	www.dlp.com
DSP	dsp.ti.com
Clocks and Timers	www.ti.com/clocks
Interface	interface.ti.com
Logic	logic.ti.com
Power Mgmt	power.ti.com
Microcontrollers	microcontroller.ti.com
RFID	www.ti-rfid.com
OMAP Applications Processors	www.ti.com/omap
Wireless Connectivity	www.ti.com/wirelessconnectivity

Applications

Automotive and Transportation	www.ti.com/automotive
Communications and Telecom	www.ti.com/communications
Computers and Peripherals	www.ti.com/computers
Consumer Electronics	www.ti.com/consumer-apps
Energy and Lighting	www.ti.com/energy
Industrial	www.ti.com/industrial
Medical	www.ti.com/medical
Security	www.ti.com/security
Space, Avionics and Defense	www.ti.com/space-avionics-defense
Video and Imaging	www.ti.com/video

TI E2E Community

e2e.ti.com